

# 11

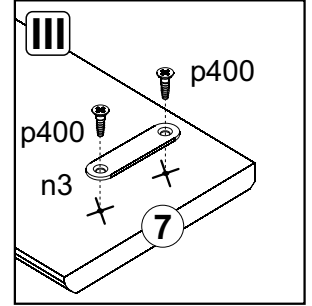

# 12

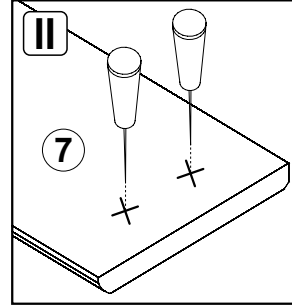
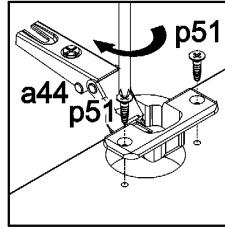
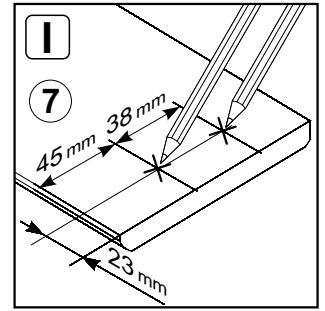
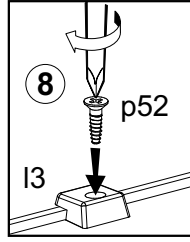
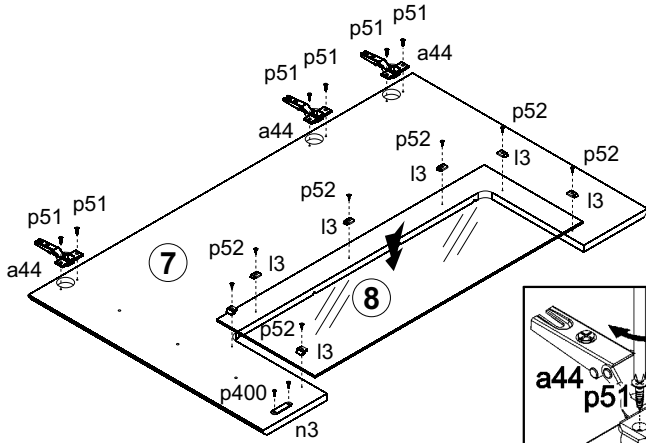
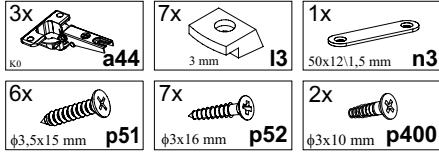
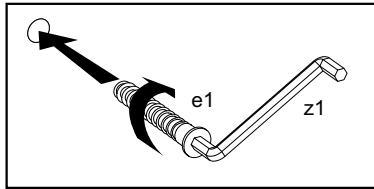
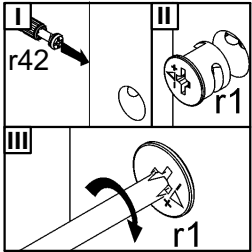
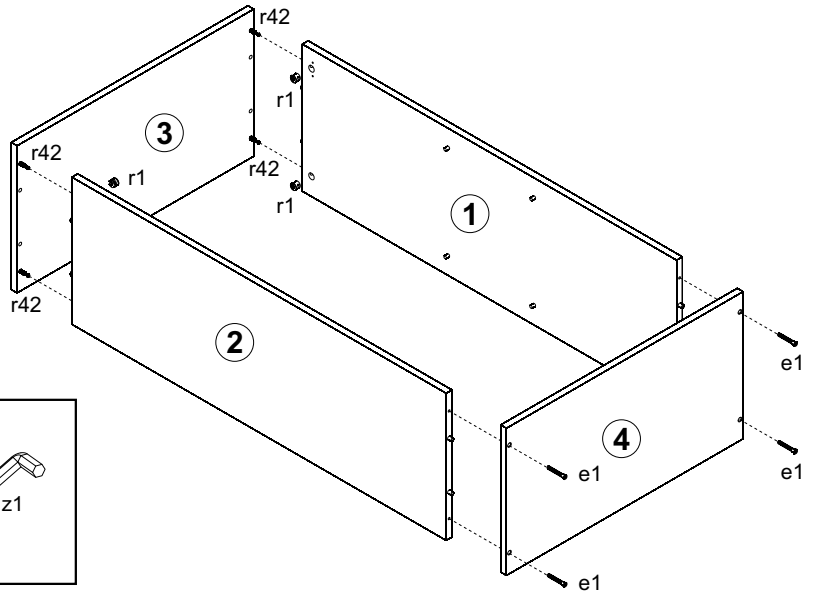
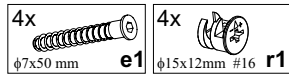

# 13

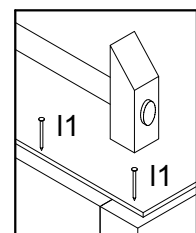
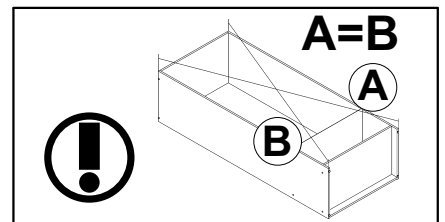
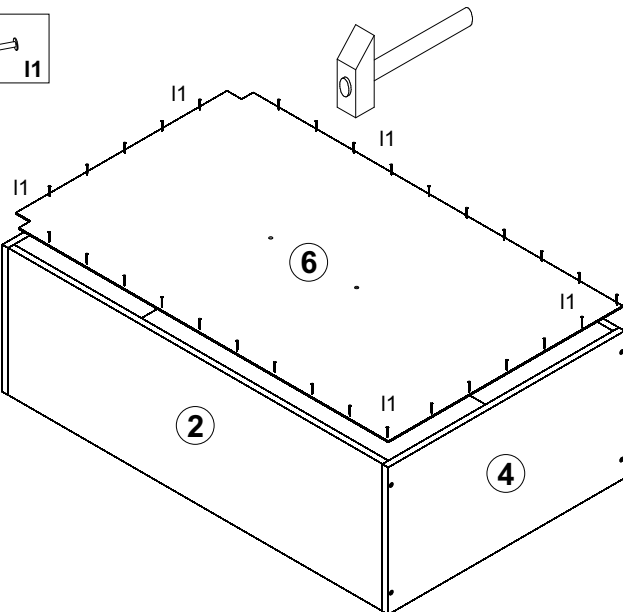

# 14

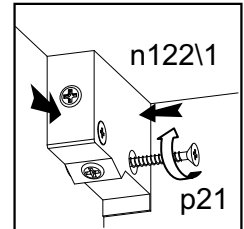
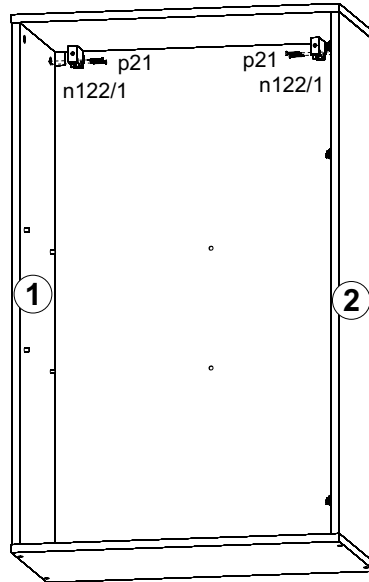
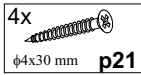

# 15

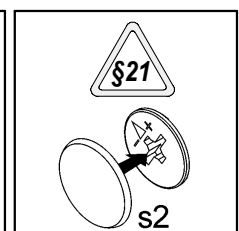
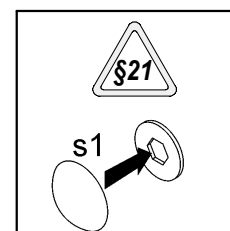
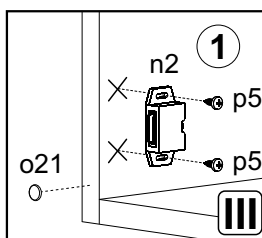
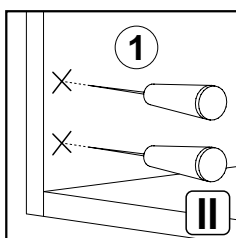
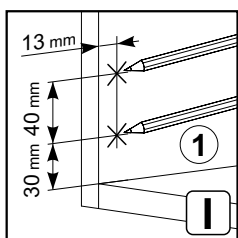
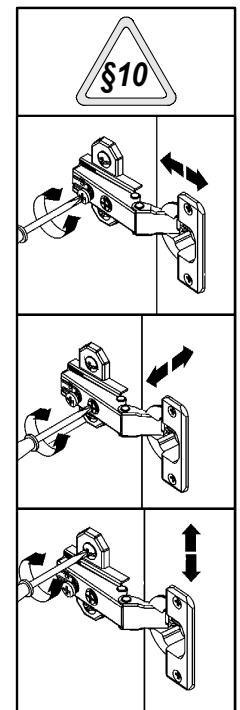
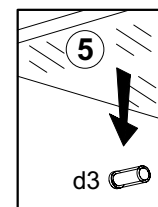
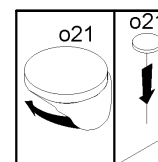
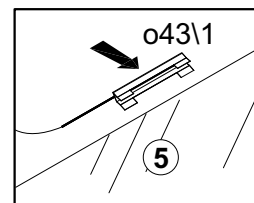
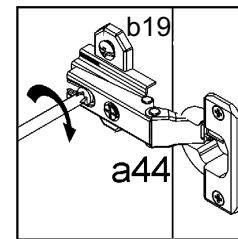
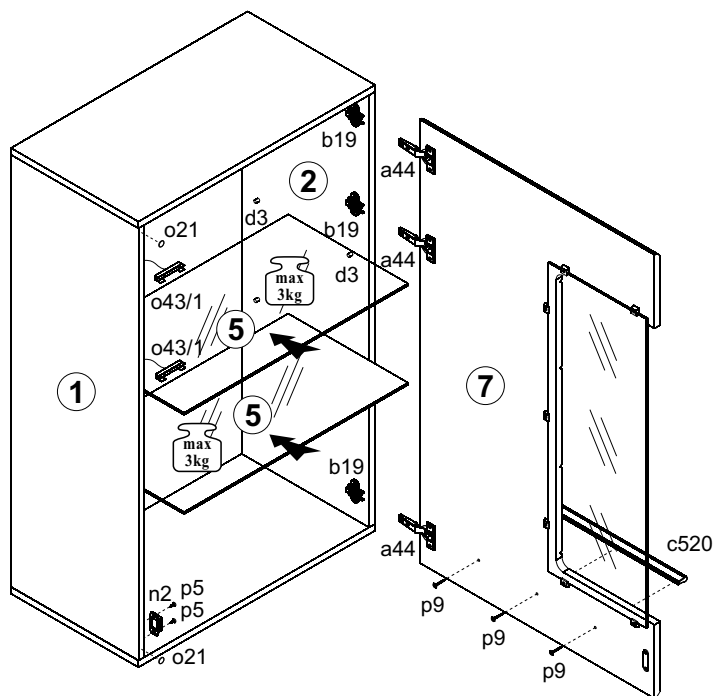
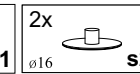
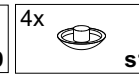
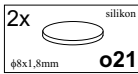
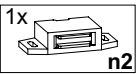
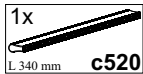

# IV Полиця / Полка

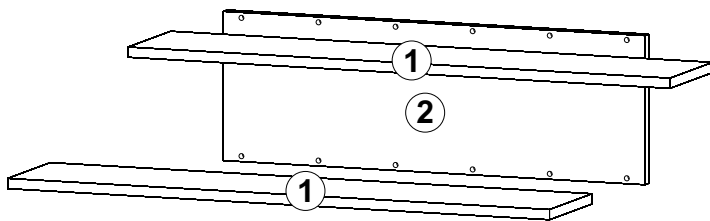
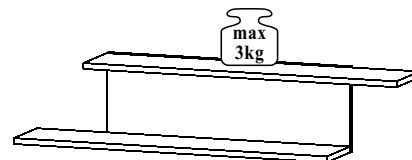

A	B	C	D
1	ML1-303	900	180
2	ML1-401	700	233

## 16

- 12x  $\phi 7 \times 50$  mm e1
- 2x  $\phi 6,3 \times 13$  mm e2
- 4x  $\phi 5 \times 11$  mm e4
- 2x g2
- 1x z1

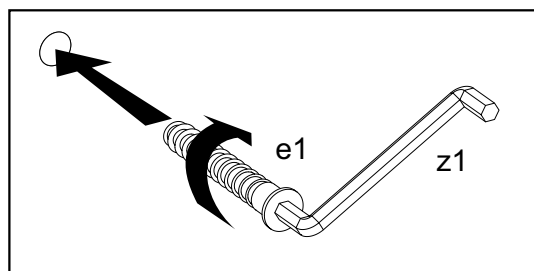
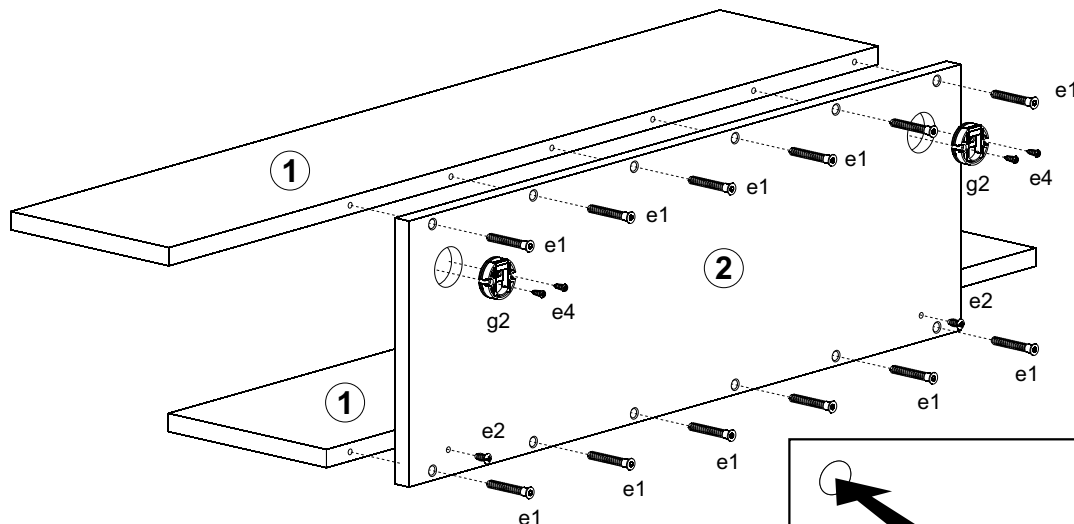

## 17

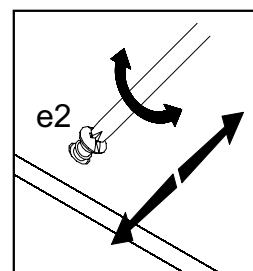
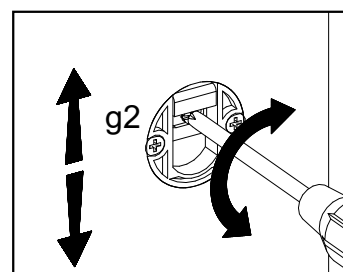
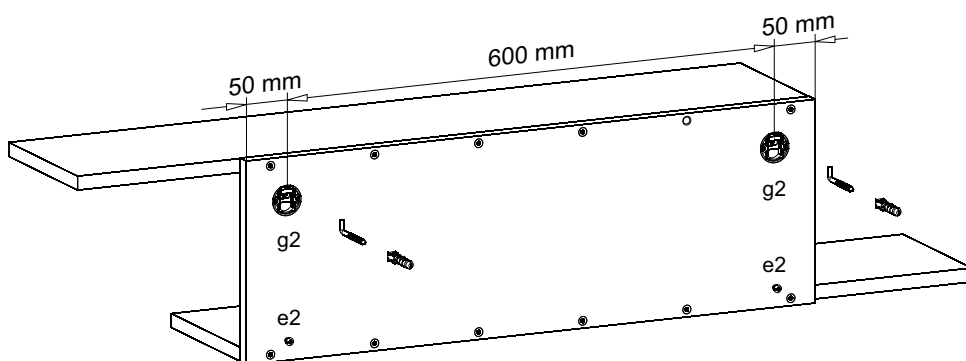
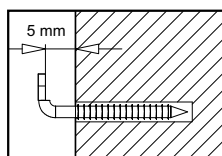
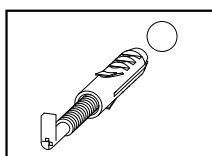
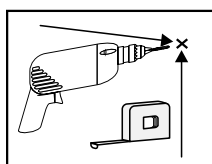

# 18

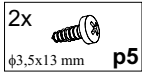
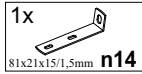
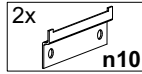

25 mm 64 mm

64 mm 25 mm

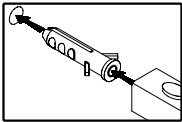
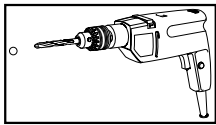
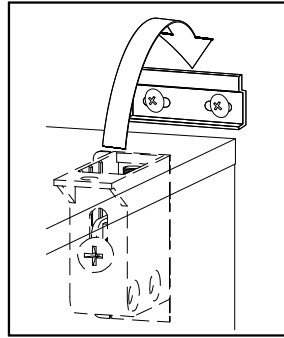
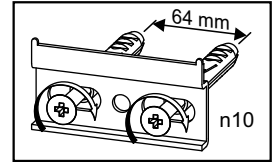
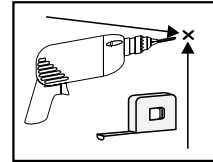

n14

