

# ПОЛА / POLA

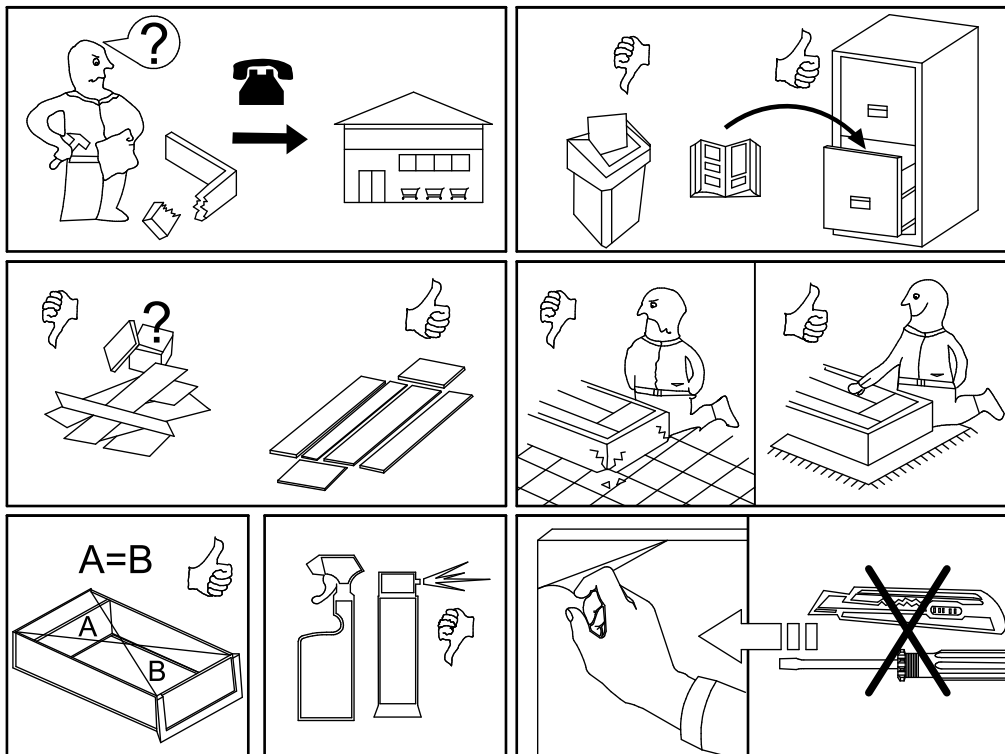

200  
190  
180  
170  
160  
150  
140  
130  
120  
110  
100  
90  
80  
70  
60  
50  
40  
30  
20  
10  
0

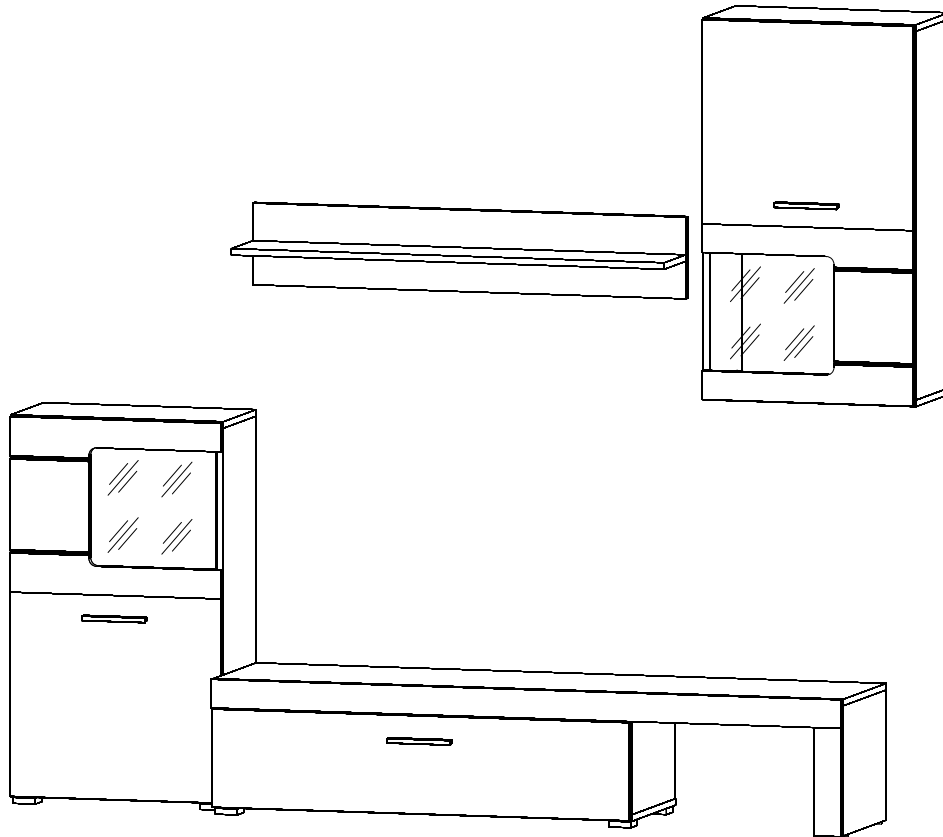
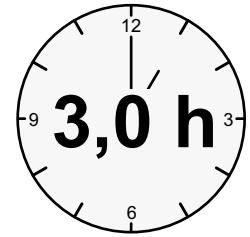
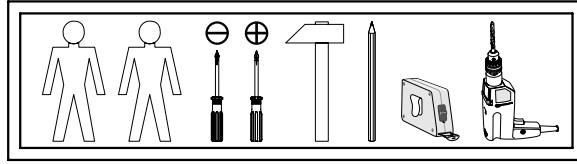
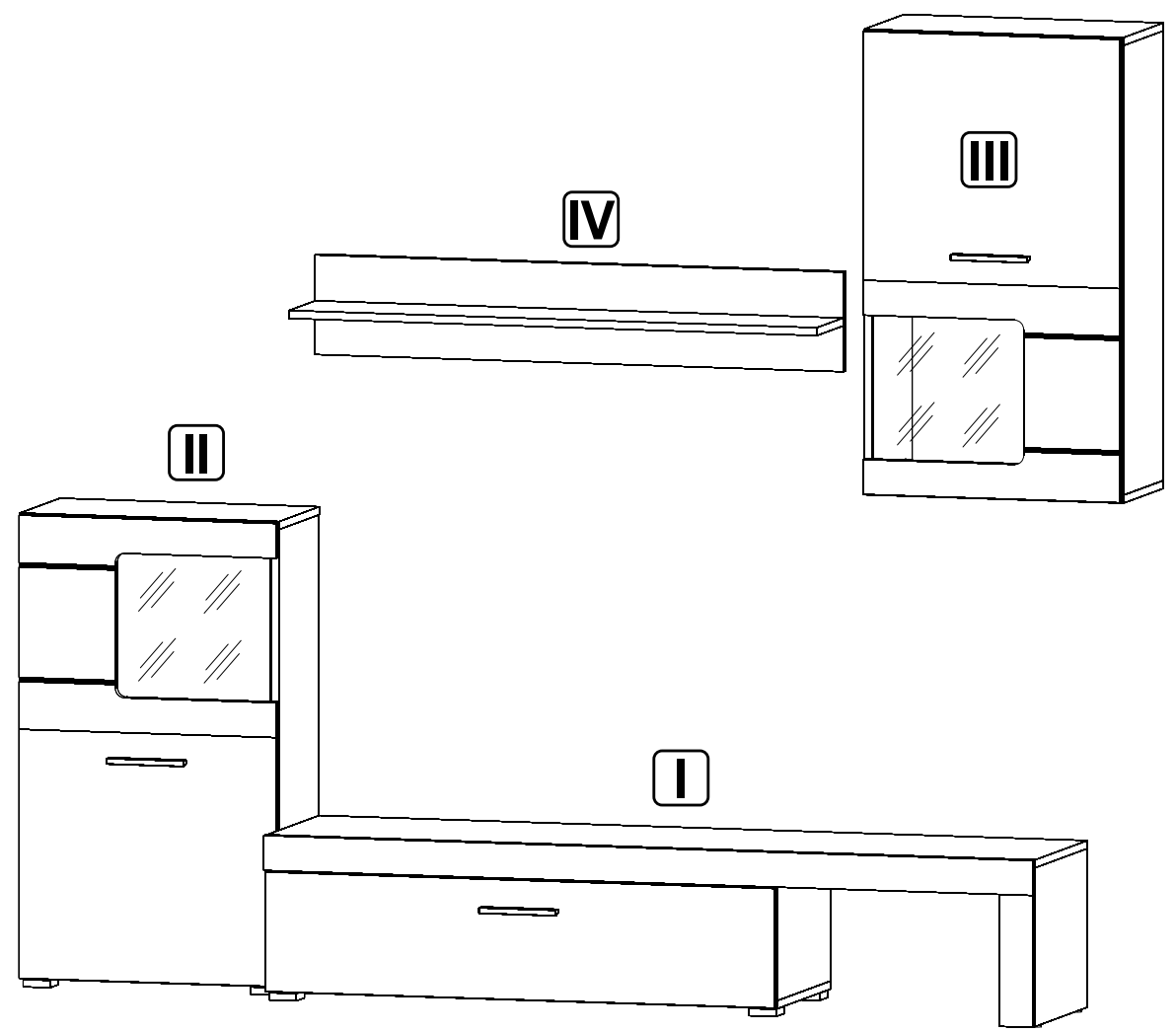

- |                                   |                                      |                                   |                                 |  |                                     |
|-----------------------------------|--------------------------------------|-----------------------------------|---------------------------------|--|-------------------------------------|
| 8x<br><br>K0<br><b>a44</b>        | 8x<br><br><b>b19</b>                 | 3x<br><br><b>c328</b>             | 8x<br><br>φ5x17 mm<br><b>d1</b> | 13x<br><br>φ7x50 mm<br><b>e1</b>       | 2x<br><br>φ6,3x13 mm<br><b>e2</b>   |
| 4x<br><br>φ5x11 mm<br><b>e4</b>   | 42x<br><br>φ8x30 mm<br><b>f1</b>     | 5x<br><br>φ8x50 mm<br><b>f6</b>   | 2x<br><br><b>g2</b>             | 2x<br><br><b>k1</b>                    | 8x<br><br>56x56/20 mm<br><b>k52</b> |
| 82x<br><br><b>l1</b>              | 12x<br><br>3 mm<br><b>l3</b>         | 2x<br><br><b>m48</b>              | 2x<br><br><b>n10</b>            | 1x<br><br>81x21x15/1,5mm<br><b>n14</b> | 2x<br><br><b>n122/1</b>             |
| 1x<br><br><b>o100</b>             | 8x<br><br>φ3,5x13 mm<br><b>p1</b>    | 2x<br><br>φ3,5x13 mm<br><b>p5</b> | 6x<br><br>φ4x30 mm<br><b>p9</b> | 20x<br><br>φ4x30 mm<br><b>p21</b>      | 16x<br><br>φ3,5x15 mm<br><b>p51</b> |
| 12x<br><br>φ3x16 mm<br><b>p52</b> | 48x<br><br>φ15x12mm #16<br><b>r1</b> | 5x<br><br><b>r10</b>              | 38x<br><br>20/9<br><b>r16</b>   | 26x<br><br>ø16<br><b>s2</b>            | 4x<br><br>ø16<br><b>s2</b>          |
| 1x<br><br><b>z1</b>               |                                      |                                   |                                 |  |                                     |



# Тумба PTB / Szafka RTV

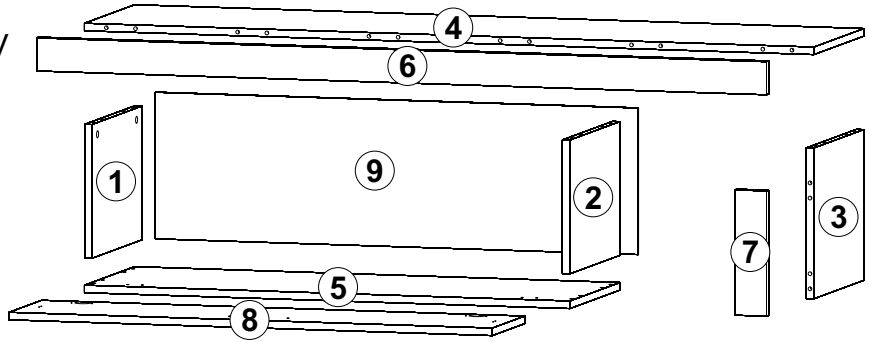
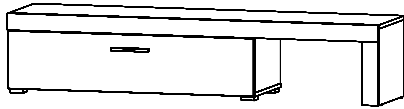

A	B	C	D
1	PRO-101	283	370
2	PRO-102	283	370
3	PRO-103	314	370
4	PRO-201	1600	370
5	PRO-202	1065	370

A	B	C	D
6	PRO-401	1601	70
7	PRO-402	261	70
8	PRO-002	1060	240
9	PRO-901	1059	310



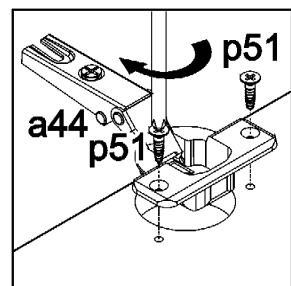
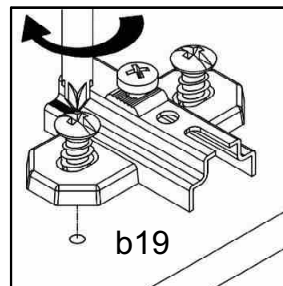
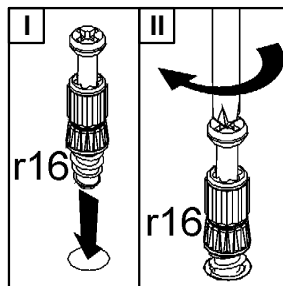
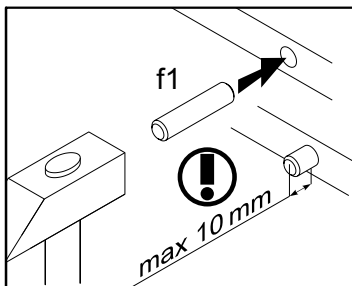
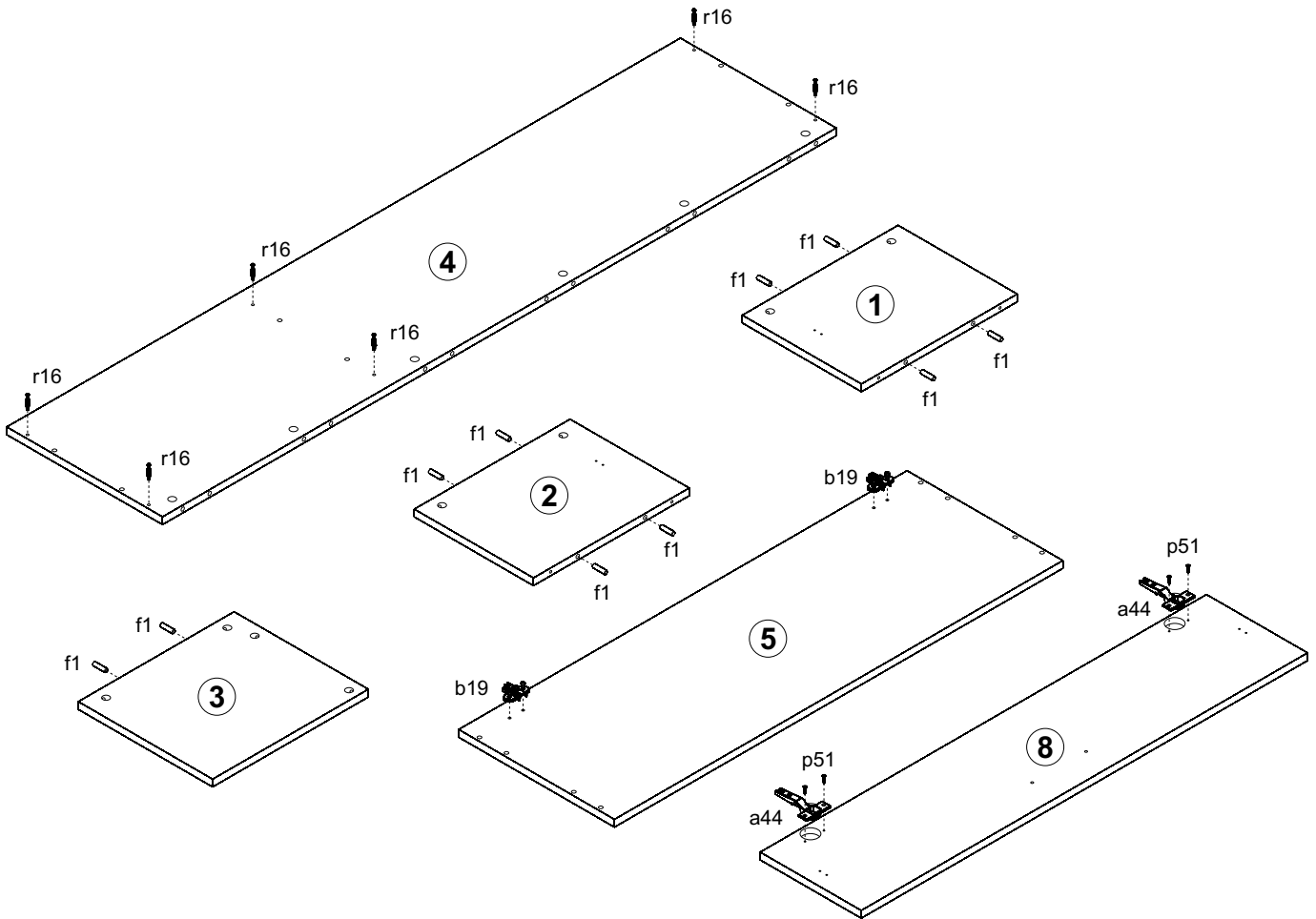
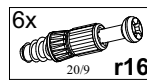
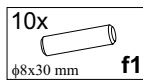
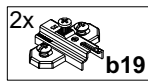
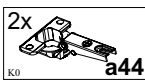

# 1

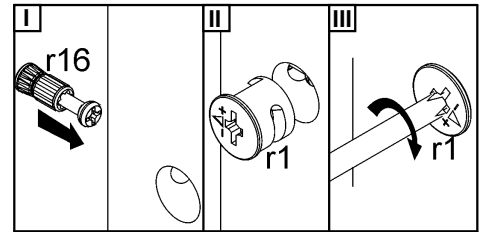
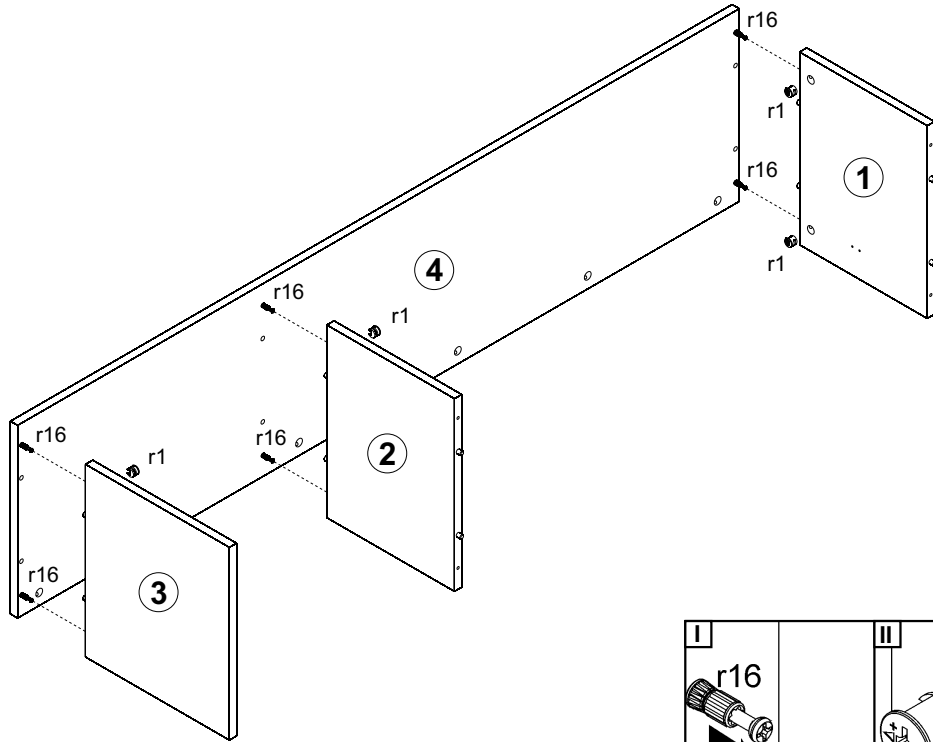

**2**

6x  
  
 $\phi 15 \times 12 \text{ mm}$  #16 r1

**3**

4x  
  
 $\phi 7 \times 50 \text{ mm}$  e1

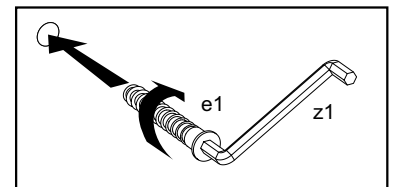
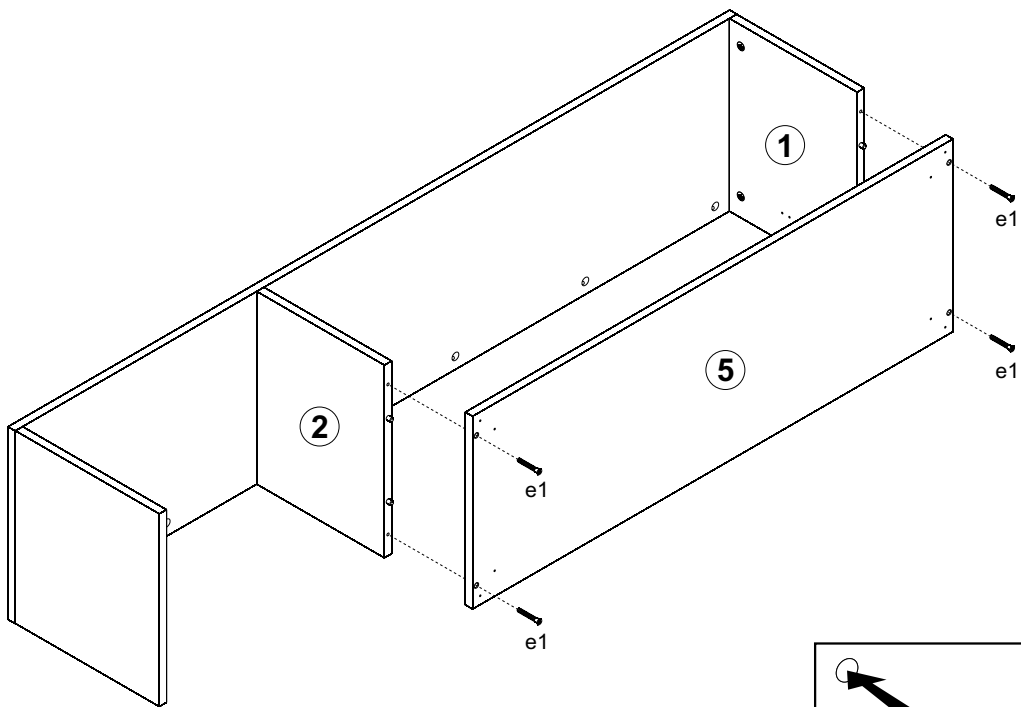

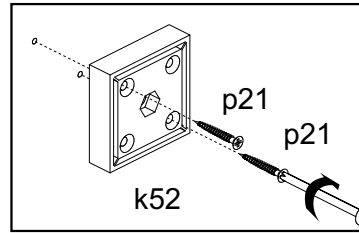
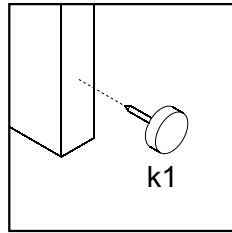
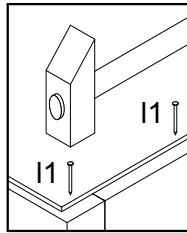
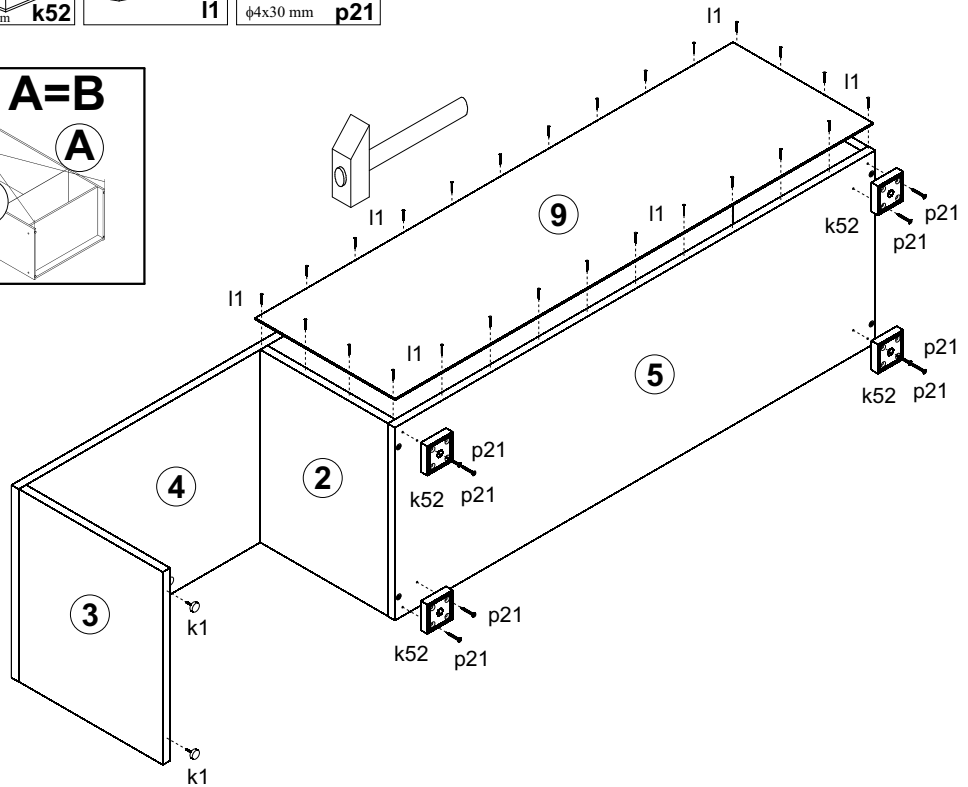
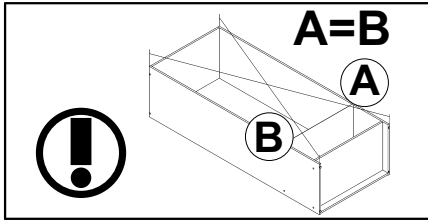
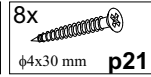
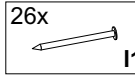
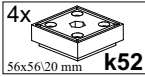
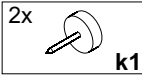
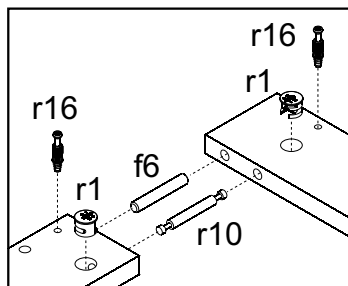
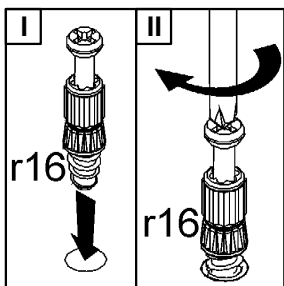
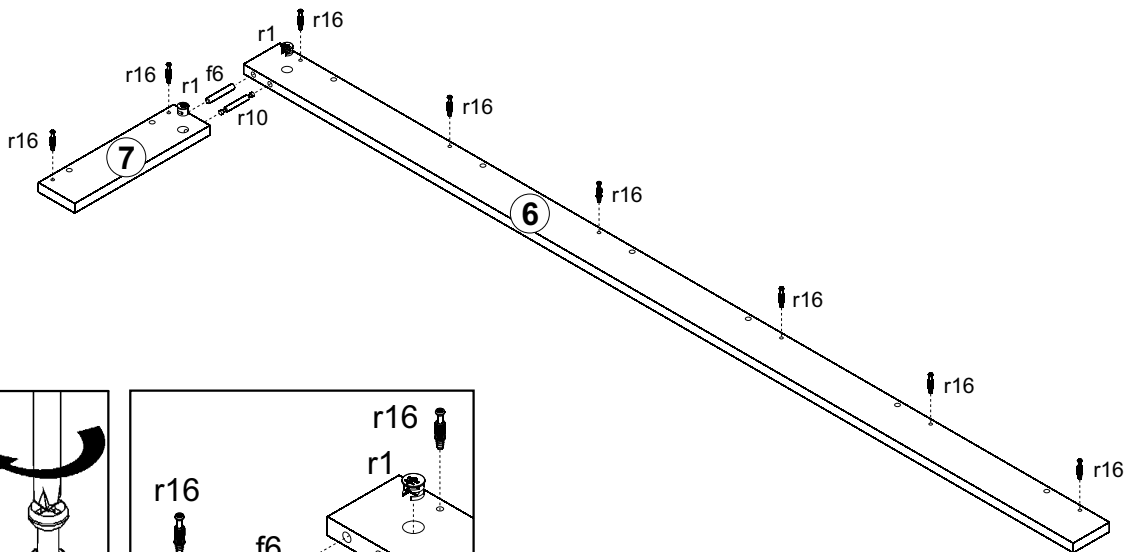
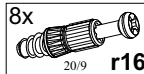
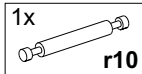
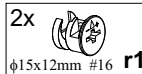
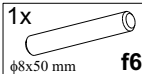
**4****5**

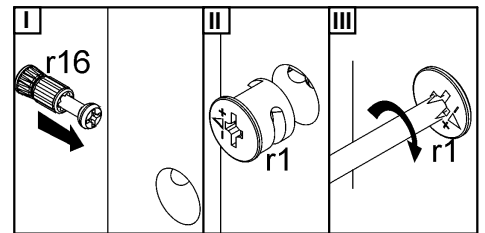
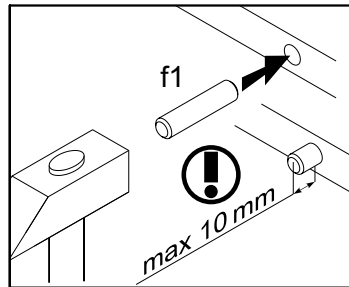
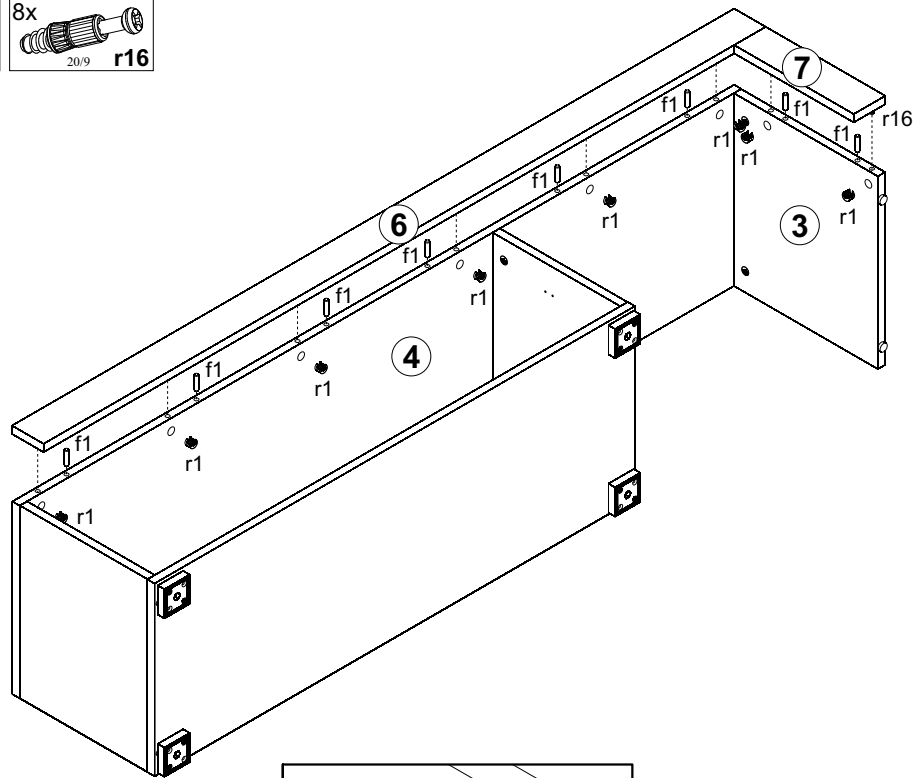
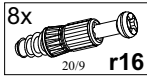
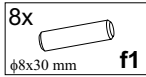
**6****7**